

# Contractor Resources

Faster. Stronger. Greener.



**Website:** [premiersips.com](http://premiersips.com)

**Toll Free:** 800-275-7086

*Details, illustrations, pictures, and guidelines provided in this Resource Manual give basic information and illustrate examples of Premier SIPS design & installation recommendations. The basic information provided herein is not intended to cover every potential use and application of Premier SIPS. It is the responsibility of the owner and/or the owner's representative to design the insulated wall assembly to perform in a manner ensuring function and durability. Adding an additional insulation component may change the behavior of a wall assembly regarding air movement, water vapor transmittance, bulk water management, and heating, cooling, and ventilation systems. It is the responsibility of the installer to become familiar with each specific application and determine if Premier SIPS are suitable. By commencing work, the installer accepts full responsibility for the proper and safe installation of Premier SIPS at each job site. Furthermore, it is the sole responsibility of the installer to meet all federal and local regulatory requirements for job site safety for every person on the job site while in the execution of all phases of the SIP installation.*

# CONTRACTOR RESOURCES: CONTENTS

## ORDERING & PRODUCTION PROCESS

- The Premier Ordering Process.....CR-2
- Detailed Premier Project Lifecycle .....CR-3
- Guide For Reviewing  
Layout Drawings..... CR-8
- Premier SIPS Layout Drawings  
Review Checklist.....CR-10

## INSTALLATION GUIDELINES

- 5 Steps To Take Prior To SIP  
System Delivery .....CR-11
- Recommended SIPS Installation Tools...CR-11
- Quick SIPS Jobsite Installation  
Best Practices.....CR-12
- SIPS Delivery Preparation ..... CR-13
- Detailed Installation  
Recommendations.....CR-14



## THE PREMIER ORDERING PROCESS

You are on your way to building one of the highest performing building envelopes available. When you choose Premier SIPS you are making a positive impact to create more energy efficient, stronger, and healthier commercial and residential structures. The SIP Layout Drawing and Production process depends on a number of factors. The most important thing to remember is that this is a two step process: First we must work with you, our client, and possibly 3rd parties to create the SIP Layout Drawings, and once completed we enter the production schedule.

The text box colors in each stage of the process have been broken into two categories:

Client Responsibility

Premier Building Systems Responsibility

Due to the extreme variability in the time it takes for projects to progress through the drawing process, it isn't possible for us to reserve a production slot until step #6.



# DETAILED PREMIER PROJECT LIFECYCLE

On behalf of Premier Building Systems (Premier), we would like to thank you for placing your confidence in our products. You have chosen what many in the building industry believe to be the future of building – SIPS! We feel you are purchasing the best structural insulated panels manufactured in America today.

The process used to create a structure using SIPS is a bit different than traditional construction. Premier SIPS are manufactured with extreme precision in our state-of-the-art manufacturing factories. Just like a window and cabinet package is custom manufactured to each project, successful SIPS installations require pre-planning before factory production and jobsite delivery. This upfront pre-planning can significantly reduce the installation time in the field.

This document is designed to walk you through the steps in this process. As we work together to complete your project, the following pages outline the process and explains what to expect during the project lifecycle. Please refer to these guidelines often as we progress through the milestones of your Premier SIPS project.

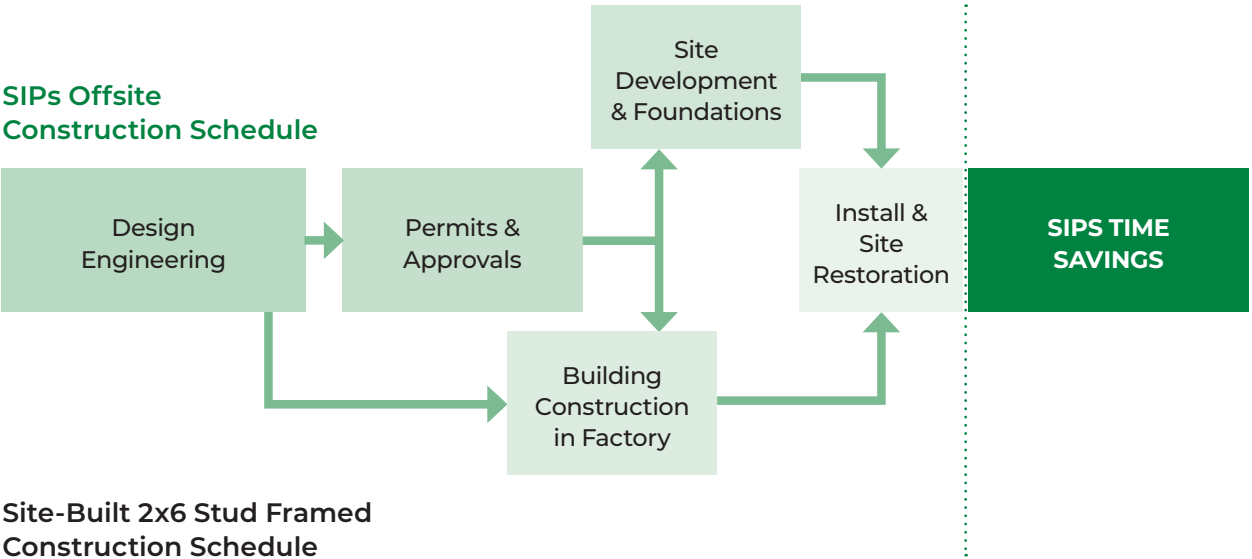

## THE PROCESS ... STEP-BY-STEP

### 1. SUBMITTAL OF PLANS FOR AN ESTIMATE

Architectural or designer building plans are submitted to your local Premier SIPS Representative to establish a Project Estimate (electronic file formats, such as a .PDF are appreciated). In most cases your Premier Representative will provide a project estimate within 5-10 business days. The more detailed your building plans, the more accurate we can be in providing you an accurate estimate. However, Premier is providing an estimate based on the initial information provided. There are often changes made by the customer, architect, engineer or builder, as well as alterations to layout requirements that are very difficult to estimate prior to final SIP drawings being signed and approved.

### 2. APPROVING THE ESTIMATE

Along with pricing, the “Project Estimate” includes the terms and conditions from which both parties will be operating. It will be necessary to sign and return the document, acknowledging you understand these terms and conditions and that you would like Premier to proceed. For an Estimate to be approved and the project to begin, Premier requires the following:

- Signed estimate with the attached Terms and Conditions by legal/authorized project representative.
- A non-refundable deposit to initiate the drafting and project management process.

### 3. PREMIER POINT OF CONTACT

You will be assigned a dedicated Premier SIPS Project Manager. Your “PM” will be your primary point of contact throughout the duration of your project. He or she will provide you with interpretive SIP Layout Drawings (Layout Drawings), typically within 10 business days of Premier’s receipt of the completed elements in #2, for your review and approval.

### 4. CUSTOMER REVIEW OF SIP LAYOUT DRAWINGS

Your review of the Layout Drawings is the most critical component of the entire process. It will set the stage for Premier manufacturing to fabricate the SIPS to your specifications. The Layout Drawings you receive from your PM are interpretations of the building plans you have provided. It is ultimately your responsibility to review these Layout Drawings for accuracy and approve them by signing each drawing in the set. We strongly encourage you to utilize a lead design professional, either an architect or experienced builder, while reviewing your drawings.

### 5. SIPS ENGINEERING

If Engineering is required, an additional deposit may be required at time of service (Contact your PM). If some engineering cost was included as part of the estimate, when the actual engineering costs are determined, they will be included on the Contract of Sale (COS) with the additional deposit being applied against the total price on the COS.

## 6. REVISION PROCESS

It is very likely you will have modifications to the Layout Drawings you receive. Once Premier receives your “red-lined” (marked-up) changes, we will make every effort to get the drawings revised and back to you within 5 business days. A marked-up set of Layout Drawings is the preferred method to communicate changes or corrections. Verbal changes or an emailed list may delay revisions or cause an additional set of revisions. It is important to review your entire set of revised drawings, as a revision to one component may affect adjacent SIPs.

There are occasions where this process of revisions may take more than one cycle. Depending on the number of revisions made, the review process will vary in length. As the reviewer, you have a great deal of influence on the overall revision process and its effect on the total project lifecycle. Two rounds of revisions/edits are included in the initial pre-production services portion of the Premier SIPS estimate. Additional revisions may incur additional fees.

## 7. RECEIPT OF FINAL APPROVED DRAWINGS

Once your Premier SIPS PM receives the final approved and signed SIP Layout Drawings, they are then turned into production-ready drawings, known as “Production Details” from which Premier Manufacturing will fabricate your SIPs. This step also requires “nesting” of the panels for best utilization; safe stacking; and any sequencing requirements you may have. Your PM determines the final material requirements based on these production drawings, develops a final “Contract of Sale” (COS) incorporating the final price (including revisions and any change orders). The COS will be submitted to you within 5 business days for your signed approval.

## 8. APPROVAL TO PROCEED WITH PRODUCTION

Your approval and return of the signed Contract of Sale (COS), along with a down payment in the amount of 50% of the project’s contract price will initiate the production process. Projects will not go into production without this down payment. Payments can be made via credit card (3% fee applied to credit card transactions), wire transfer or check. However, if paying by check, there is the possibility of delays based on the time it takes for the check to clear. Please keep this in mind as production will not begin until the check has cleared.

At this point, it is extremely important that you are completely ready to proceed. Your project is unique and custom fabricated, which means Premier is unable to resell or restock your products after manufacturing. As a result, by giving approval to manufacture, you will be liable for the project, even if for some unforeseeable reason you must cancel. If you have any questions, please contact your PM prior to submitting the COS.

## 9. PRODUCTION

After the signed COS & 50% down payment have been received and funds have cleared, the project will be put into the production schedule. Important note: We need to have signed Layout Drawings, signed COS (or PO for applicable customers), and down payment prior proceeding any further. Projects will ship from our manufacturing facility based on our current lead time (Contact your PM). Lead time is determined after receipt of the signed COS and the clearing of funds (item #8). Once your project has entered production, any changes made to the project at this time may result in a delayed shipment (and additional charges), as changes cannot be made to SIPS once fabrication has begun.

## 10. SCHEDULING DELIVERY OF PREMIER SIPS

Within 10 business days of your project entering production, the Premier Shipping Manager will contact you to confirm/schedule your delivery date (based on the date in your COS). The final balance due must be paid in full (and all funds made via check must clear) before the Shipping Manager can release your completed project for shipment – unless other arrangements have been made.

## 11. PAYMENT OF OUTSTANDING BALANCE

Payment of the balance for the project is due prior to shipping unless previous arrangements have been made. If paying by check, please allow time for transit and time for check to clear. Delays in payment may result in delays or cancellations of shipment, which in turn may cause additional charges as noted below in item #14.

## 12. PREPARING FOR RECEIPT OF YOUR PREMIER SIPS

The last two pages of the COS provide a detailed overview concerning the delivery of your Premier SIPS. We strongly encourage you to revisit this document a few days prior to delivery to insure you are in position to receive the product.

Unlike the many pieces used in conventional framing, SIPS take up a large footprint. Planning through this stage for your construction site will make it easier for SIPS installation.

## 13. RECEIVING YOUR PREMIER SIPS

It will be necessary to have someone on site to receive the shipment. This person must physically inventory the Premier SIPS and other materials delivered based on the packing list provided with the shipment. If anything is missing or damaged, you must make note of it on the "Packing Slip" provided by the Delivery Driver. Then notify your Premier PM immediately in order to assist with remedying the situation. There are occasions, due to the customization of each SIP and particularly with smaller SIPs, that it might appear a SIP is missing, when in actuality, it resides within the shipping load, but nested among other SIPs. Through our load diagrams and pictures taken during load-out of the trucks, our shipping staff should be able to help if something is believed to be missing. Again, it is critical to document damaged or missing pieces on the "Packing Slip" and to notify your Premier PM immediately if there are any possible concerns with the load.

Per the Terms and Conditions included with the estimate document, it is necessary to notify Premier, in writing, within 15 days of delivery, should you find any perceived defects or non-conformance of the product you received. Beyond this period, the product will be considered to have been received without exception. If, for any reason, you do not plan on installing the Premier SIPS within 15 days of delivery, an inspection and notification of any non-conformance, would still be required within this time period for a claim to be considered.

## 14. DELAYS TO DELIVERY

We recognize delays occur with projects. At the same time, it is very difficult for us to store and maintain projects in a protected environment once they have been produced.

To accommodate slight schedule delays, Premier will store panels up to 1 week beyond the scheduled delivery date at no charge. Beyond this period, there will be a weekly charge of \$300 (per truckload) per week for storage. If the project is delayed beyond one month, Premier will invoice the customer to pay the full balance due upon invoice receipt. Additionally, any delays to delivery within 48 hours of the scheduled shipment will result in an additional \$350 freight rescheduling fee. It is in no way Premier's desire to pursue these fees, but the liability of storing and the inability to restock custom manufactured products affects Premier's ability to operate effectively.

## LAYOUT DRAWINGS & CONSTRUCTION DETAILS

As mentioned throughout the process, each custom Premier SIPS package will be delivered with Layout Drawings, which include specific Construction Details for each project. Keep these in a safe place on the jobsite, as Contractors and Installers will refer to these often.

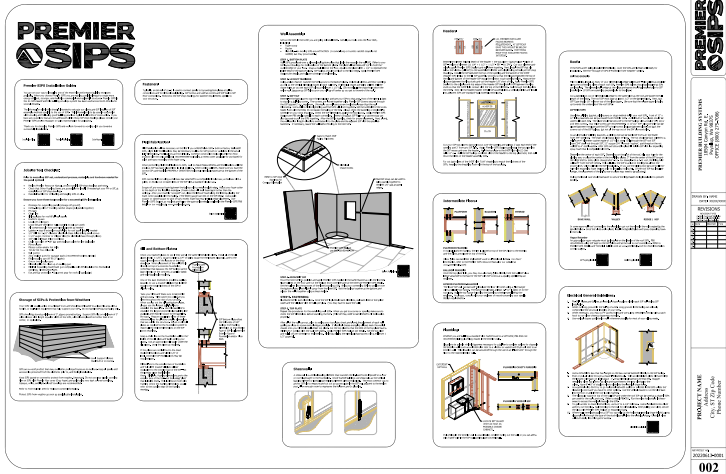

We hope these guidelines help layout the process from approval to proceed with drafting through the receipts of your Premier SIPS order. Typically, you can expect a project to take from 4-12 weeks, but that time frame can vary significantly for a variety of reasons. The customer review, permit process, engineering changes, customer approval and payment steps are elements over which, you as the customer, have control, and when not performed in an expedient manner, can add days, weeks, or even months to the project timeline.

It is our overriding mission to provide you with the product you want, when you want it, to the standards you expect. You have shown, by purchasing Premier SIPS, that you are willing to invest in the very best products available to construct your building envelope. We are honored to have the opportunity to be a part of this investment. Please contact us with any questions before, during, or after construction.



# GUIDE FOR REVIEWING LAYOUT DRAWINGS

---

1. The SIP Layout Drawings for each project are based on the information furnished to Premier Building Systems (Premier). Proper installation of Premier SIPS should be done by a licensed Contractor. It is the Contractor's responsibility to comply with all applicable federal, state, and local codes, regulations, and safety measures.
2. Premier SIP Layout Drawings are for illustration purposes and SIP assembly. As such, these SIP Layout Drawings are not to be considered a replacement for the expertise of an Architect or Engineer, nor their drawings. These SIP Layout Drawings exclude any design of site, foundation, mechanical, electrical, or plumbing. SIP Layout Drawings are to be used in conjunction with Architectural and Structural Drawings. If anything is not clear or there are questions they should be immediately directed to the Architect or Engineer of record.
3. Premier makes every effort to supply complete SIP Layout Drawings from the original Architectural and / or Structural Drawings provided to us. It is the responsibility of the Contractor or Owner to check and verify all dimensions, notes and details on the SIP Layout Drawings for compatibility with the Architecturals and other consultants' drawings and existing conditions prior to commencement of work (check list for this follows). Premier SIPS are fabricated per these SIP Layout Drawings. Any discrepancies or missing items in these Layout Drawings should be noted.
4. Should any discrepancies or omissions be found, the Contractor or Owner must notify your Premier Representative in writing, as soon as possible so that corrections can be made before SIP fabrication begins. A Contractor should look through the plans carefully to ensure that all aspects of the SIP package can be constructed through their preferred means and methods prior to signing off on the SIP Layout Drawings.
5. The Contractor or Owner shall notify premier in writing of any changes to the site and field condition which may affect the SIP layout, prior to the start of SIP fabrication.
6. It is the Contractor's or Owner's responsibility to provide a level and square foundation to ensure a good fit of the Premier SIPS. Premier does not assume responsibility for any variances from the final signed Layout Drawings, including any specifications or adjustments required resulting from the conditions encountered on the job site.
7. The details on the Layout Drawings may not be all inclusive. SIPS must be installed per the Premier SIPS Resource Manual. All available construction details can be found in the Resource Manual or at [www.premiersips.com](http://www.premiersips.com).
8. Some dimensions can not be verified until constructed. Therefore, Premier takes no responsibility for field fabrication. Some field fabricated areas may have been highlighted on the SIP Layout Drawings, but may not be limited to only those areas.
9. It is the Contractor's responsibility to determine all materials necessary for SIP installation. This includes verifying that the materials Premier will be providing (per the Contract of Sale) are adequate for the project and sourcing any additional materials required for SIP installation. All dimensional or engineered lumber, steel, etc. used for any purpose and not noted on the Layout Drawings, shall be supplied by others. Required support beams, columns, dimensional lumber and headers not noted on the Layout Drawings must be designed and supplied by others. Contractors should contact your Premier Representative for clarification on any material needs – ideally prior to SIPS production.

10. SIP wall and/or roof Layout Drawings include locations of factory electrical chases as indicated in the legend below. Additional “custom” electrical chases may be added for a fee. All field cuts, including electrical and plumbing chases, must be in accordance with the Premier SIPS Resource Manual, or pre-approved by Premier.
11. The Contractor or Owner is responsible for verifying all SIP Layout Drawing dimensions to ensure compliance with Architectural and Structural Drawings. All corrections must be “red-lined,” including accurate dimensions, on SIP Layout Drawings in order for Premier to revise the Drawings. If applicable, indicate which end of the dimension will be relocating. Unchecked dimensions may result in the need for field fabrication.
12. Premier accepts no responsibility for Construction, Architecture, or Engineering.
13. Execution of work for installing a SIP package may require coordination with other trades (i.e. Electrician, HVAC,, Plumber, Window/Door Installer, etc.). This coordination is the responsibility of the Contractor.
14. All elevations drawn are viewed from the exterior unless otherwise noted.
15. When built properly a SIP building provides a tight envelope. It is the responsibility of the Contractor to ensure that the SIP structure is properly ventilated to ensure proper air quality and humidity levels.
16. It is the Contractor’s sole responsibility to ensure that all spline connections are properly seated into the SIP recesses and completely sealed with Premier Sealant and SIPS Tape per Premier SIPS Construction Details. Voids between spline connections/joints are not acceptable in a proper SIP installation. Only use expanding spray foam where indicated within Premier SIPS Construction Details, including but not limited to, penetrations, lifting holes, electrical boxes, top of SIP wall/roof connections, etc.
17. The Contractor is responsible to determine the proper weather barrier (i.e. building wraps, flashing, roof underlayment, etc..) to dry in the building envelope.
18. You may experience dimensional variances from the Layout Drawings as SIPS are assembled having gaps at SIP joints and additional miscellaneous construction variables such as fabrication tolerances, lumber post thickness variances, etc. Minor field cutting of the SIPS, to conform with the approved design, may be required to ensure that the total wall or roof assembly is completed per the construction drawings. Premier will add gaps as indicated on SIP Constuction Details between panel joints (typically 1/8” gap).
19. Consult your Premier Sales Representative or Project Manager if field modifications to the SIPS are required due to deviation from the approved SIP Layout Drawings for any reason.

# PREMIER SIPS LAYOUT DRAWINGS REVIEW CHECKLIST

---

Two rounds of revisions/edits are included in the initial pre-production services portion of the Premier SIPS Estimate. Additional revisions may incur additional fees.

When you have finished verifying the SIP Layout Drawings and have made any changes/corrections, copy those changes directly on the Layout Drawings and send back to Premier for revisions prior to production.

This checklist is being provided for the express purpose of assisting our customers in the review of these SIP Layout Drawings against the plan set currently on file and for accuracy and completeness. This helps ensure the quality of the product and ease of construction in the field. Please feel free to contact your premier project manager with any questions or concerns that may arise during the review process.

- Confirm window rough opening locations & dimensions
- Confirm door rough opening locations & dimensions
- Confirm wall plate height dimensions
- Confirm roof pitches
- Confirm roof overhang dimensions
- Confirm beam sizes and locations
- Confirm design value criteria (this page)
- Confirm overall wall dimensions including steps in foundation if applicable
- Confirm floor thickness and dimensions
- Confirm SIP floor panels have solid blocking at point loads
- Denote any custom electrical chase locations with dimensions
- Sign the signature block in lower right corner of this sheet

Any and all discrepancies related to SIPs on site are the responsibility of Owner unless there is a difference between fabricated SIPs and signed SIP Layout Drawings. Premier holds first right of decision to replace, repair or pay for repair of all products in discrepancy with final SIP Layout Drawings.

## INSTALLATION GUIDELINES

### SIPS DELIVERY PREPARATION

---

We do our best to ship SIPs sequenced per client request. However, we must also make best use of the available space on each shipment, and ensure that the load is safe for transportation. Bear in mind that all SIPs have markings which make for an easy identification process. If you desire a special loading plan, that request, and layout, must be made concurrent with the return of the signed SIP Layout Drawings and may be subject to an additional fee due to impact on yield, and the total number of shipments required. Premier SIPs are fabricated at 4' & 8' widths and up to 24' lengths. 6' Forks are required for 8' wide SIPs (refer to the contract of sale for more information or ask pbs for a delivery information sheet).

As a supplier of materials only, PBS does not assume responsibility for errors in design, engineering, or dimensions. Owner/agent (architect, contractor, and/or installer) shall verify all dimensions and sizes, and by signing these plans, the owner takes full responsibility for their accuracy. I understand that this structure is to be assembled in accordance with the Premier SIPs Resource Manual.

### 5 STEPS TO TAKE PRIOR TO SIP SYSTEM DELIVERY

---

1. Understand the process, gather the materials and hardware needed for a successful SIP panel system installation. NOTE: Regional Representatives may be available for job start assistance to provide recommendations on best practices.
2. Review the resources in this manual, as well as each set of project specific SIP Layout Drawings, Construction Details and notes.
3. Check that other required framing items are accessible for install.
4. If needed, ask your Premier Representative at completion of SIP Layout Drawings for clarification on any of the above.
5. Ensure a Material Handler is available for offloading and staging SIPs on site.

### RECOMMENDED SIPS INSTALLATION TOOLS

---

**Ensure you have these tools onsite for a successful SIPS installation:**

- Dunnage for supporting panels (storage off ground, set on level surface, max 4' on center)
- Come-along with 2" trucking ratchet straps (pull panels together)
- Pry bars
- Chalk line
- Lifting plates for roof & tall wall panels
- Framers square
- Levels (6' or longer)
- Loose 8d and 16d sinker nails (specific to nail gun used)

- Air compressor air hose and electrical cords as needed
- Ladders - step & extension scaffolding for roof panel install if needed
- 1/2" drill for 1-1/2" diameter electrical chase holes & long panel screws
- 1 1/2" auger, forstner or chipper bits (for electrical chase through plates)
- 3/8" drill or impact driver (cordless)
- Chain saw with 14"-16" bar and chainsaw guide for site fabrication
- Power planer
- Recess cutter and/or hot knife
- T25 & T30 Torx driver bit
- Nail gun(s)
- 20oz sealant guns for sausage packs (recommend cordless electric)
- Reciprocating saw (6" & 12" blades)
- One or two circular saws
- Mineral spirits for clean up of caulking gun
- Minimal expanding foam/foam gun compatible with EPS insulation for mechanical openings, window/door jams
- Eye and Ear protection - Fall arrest gear for roofs (if applicable)
- Forklift Notes: 6' Forks are required for 8' wide SIPs

## QUICK SIPS JOBSITE INSTALLATION BEST PRACTICES

---

1. Handle SIPs with appropriate care. Protect SIP corners and avoid lifting SIPs by edge of top facing.
2. Store SIPs and accessories a minimum of 3 inches above ground/surface. Support SIPs flat on minimum of 3" wide stickers with length equal to the width of the SIPs with stickers placed no further than four feet on center, or equivalent.
3. Protect SIPs and accessories from weather with breathable opaque, white, or light-colored coverings. **IMPORTANT!** Do not use clear or colored plastic films to cover SIPs. Keep SIPs covered to avoid exposure to weather for an extended period of time. Exposure to moisture can cause wood products to swell making installation more difficult. Protect SIPs from weather as soon as practical after installation.
4. Install fasteners flush to SIP facing surface. Be sure not to overdrive screw heads into SIP facings.
5. If field cutting openings be sure that the edge of the opening cuts stop at a common corner. Continuation of the cut past the corner significantly decreases the structural capacity of the SIP.
6. Provide level and square foundations and/or supporting floors. Remove debris from sill plate before SIP installation.
7. Install SIPs in accordance with approved drawings. Double check SIP sizes and electrical chase orientation with SIP Layout Drawings before installation.
8. Details specifying SIP tape and sealant application must be followed.
9. Provide adequate bracing of SIPs during installation.
10. Follow proper nailing requirements according to details and job specific engineering. Be sure to adjust your nail gun so that nail head is flush to SIP facings.

11. Use factory provided electrical chases in SIP rigid insulation core or surface mount conduit. SIP facing should not be cut in the field without consultation with Premier Representative.
12. Make sure to pre-drill top and bottom plates for the vertical electrical chases in the wall SIPs. Pre-drill vertical members at horizontal chase locations.
13. SIPs can be heavy. Lift and place SIPs with appropriate equipment.
14. When using 2x, engineered wood, or I-joist splines, use only continuous members; structural splines must be continuous between supports.
15. Provide appropriate bearing for roof SIPs per details.
16. For climates where SIPS tape is applied on interior joints, this should be done after roofing material has been applied.
17. Before covering roof system make certain that OSB moisture content of top+ bottom facings, and spline material doesn't exceed a maximum moisture content recommendations.
18. Make sure SIPs are clean and dry before applying interior or exterior materials.
18. All SIP roof penetrations should be reviewed by a licensed structural engineer.
20. Use code recognized flashings and exterior wall and roof coverings.
21. Use code recognized thermal barriers on interior per building codes.
22. Plumbing should not be installed within SIPs; see PBS-112 and PBS-111 for alternatives.
23. Fill all voids with expanding foam compatible with eps.
24. SIP structures should be reviewed by a licensed structural engineer. SIP supplier is not responsible for errors in design or engineering.
25. Engineered details take precedence over generic details.
26. Project must meet local code.
27. Field modifications to SIPs, such as openings and penetrations, should be reviewed by a licensed structural engineer.
28. Do not, under any circumstances, cut into the facing of a SIP without speaking to your Premier Representative. If this happens, alert a structural engineer to determine if any areas are structurally compromised.

# DETAILED INSTALLATION RECOMMENDATIONS

---

## STORAGE OF SIPS & PROTECTION FROM WEATHER

Your Premier SIPS will usually arrive on a flatbed truck and should be off-loaded to a clean flat area with a forklift, or equivalent equipment that fully support your SIPS. Do not handle SIPS by top facing only.

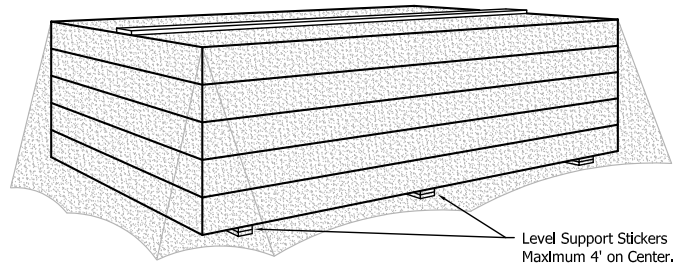

SIPs should be stored a minimum of 3" above ground/surface. Support SIPs flat on minimum of 3" wide stickers with length equal to width of the SIPS, with stickers placed no further than 4' on center, or equivalent.

SIPs are a wood product that may swell after prolonged exposure to moisture. Keep all panels and accessories protected from the elements prior to, and during installation.

Keep SIPS tarped or covered to protect from weather. Important! Do not use clear plastic covering film on SIPS with Premier Max cores (Gray foam) and avoid using very dark colored coverings. Opaque, white, and light-colored coverings are recommended.

Refer to Tech Bulletin I-3 for moisture content information.

Protect SIPS from weather as soon as possible after installation.

## FASTENERS

Typically, an 8d nail 6" (o.c.) is used to connect panels to top and bottom plates at spline connections and for dimensional plating. SIP Screws are used at corners and SIP Wall to SIP Roof connections. Reference the SIP Layout Drawings for fastener requirements specific to your structure.

## FIELD FABRICATION

Field fabrication will be necessary on the site if you ordered blank SIPS. Even on factory fabricated SIPS, slight field modifications may be necessary to allow for SIP growth or variations in the actual field dimensions. Modifications are not difficult. Common construction tools will suffice for most projects with the only additional recommended tool being a recess cutter (available for purchase) for quick and easy recessing of the foam core.

When performing field modifications to SIPS, wait to make measurements and modifications until the previous SIP has been placed into its final position. When cutting wall SIPS, make sure you have the correct SIP, and that it is PROPERLY ORIENTED (horizontal electrical chases are at the bottom of the SIP).

SIPs can be field cut using a chainsaw bar attached to a compatible circular saw, a chainsaw with a guide, or double cut on both sides of the SIP with a standard circular saw. Because SIPS are a structural assembly consult with our Premier Representative before initiating cuts to facings.

Scrape off any excess foam between the facings with a metal straight edge. Adjust your foam cutter to the depth of the installed member. (Foam cutters will melt foam back further than the setting.) After your foam is "scooped" out, clean the leftover foam along the sides by

placing the foam cutter parallel with the facing. (The depth gauge can rest on the SIP edge.) Use a paint scraper or speed square to take off any excess foam that may inhibit lumber placement. Use Premier SIPS Sealant as required and follow the appropriate details outlined in the Premier SIPS details or our website at: [www.premiersips.com](http://www.premiersips.com).

## SILL AND BOTTOM PLATES

Check your bottom plates to see if they are all the same dimension in width. Install all of the sill plates level ( $\pm 1/8"$ ), square (within a  $1/4"$  of being square on the longest diagonal), and to the exact dimensions of the layouts on the Layout Drawings. When placement of the wall SIPs is directly on top of a concrete foundation, remember that because the SIP facings cannot bear directly on the concrete, a capillary break and solid bearing is required for both SIP facings.

One of the best methods to provide a capillary break is to use a treated sill plate that is either equal to the total thickness of the SIP or slightly wider.

Take your time and make sure to be precise and accurate. Time spent now will save you time throughout the rest of your project. When you lay out the sill and bottom plates, always use the longest building line to establish the base line. Use this base line to establish the largest perpendicular building line available and make it square to the base line. Be exact. Measure parallel to either of these reference lines for all other smaller dimensions that are within the structure. Adjust or shift sill plates as required on the foundation system to match all the desired dimensions on the SIP layout drawings.

Snap a chalk line on the foundation wall for the inside of the sill plate and begin setting your plates. Use an appropriate sill sealer (Premier SIP Sealant) under the sill plates.

If the plates are not laid out to the exact desired dimensions and within  $1/8"$  of level, extensive SIP modifications may be required later.

Dimensions to the exterior face of foundation and full width treated sill plate will be equivalent to the exterior face of the SIP—not the lumber plate that is inside them. Similarly, framing dimensions are to the exterior face of the SIP—not the lumber plate that is inside them. This is different from stick framing where the framing dimensions usually refer to the outside edge of the framing member.

Reference detail PBS-305 (located in the Premier Resource Manual or at [www.premiersips.com](http://www.premiersips.com)) for additional information.

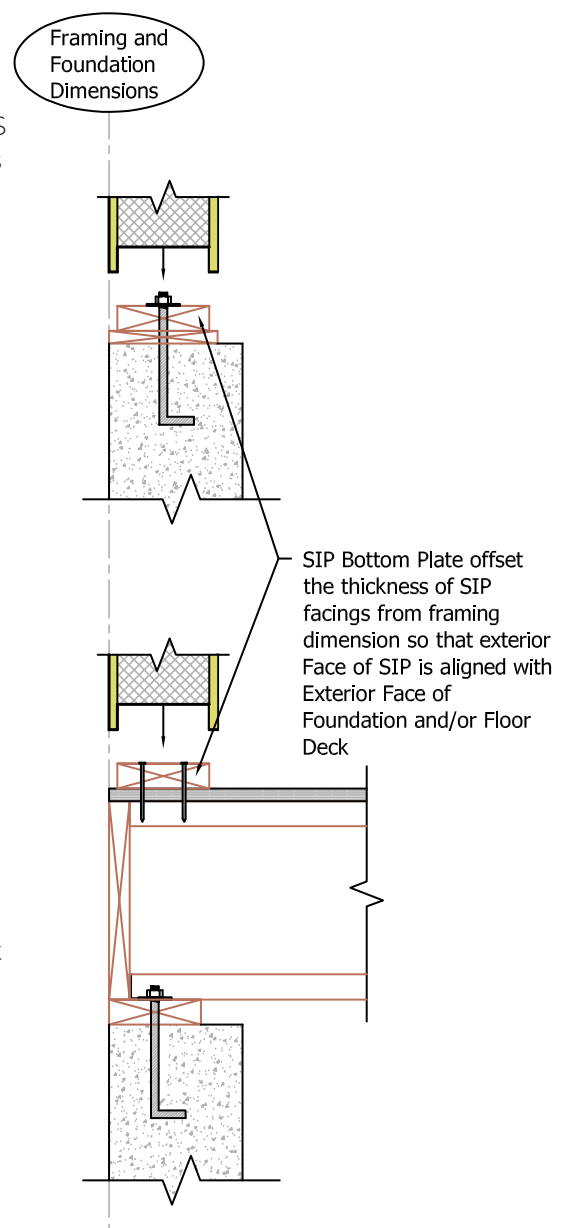



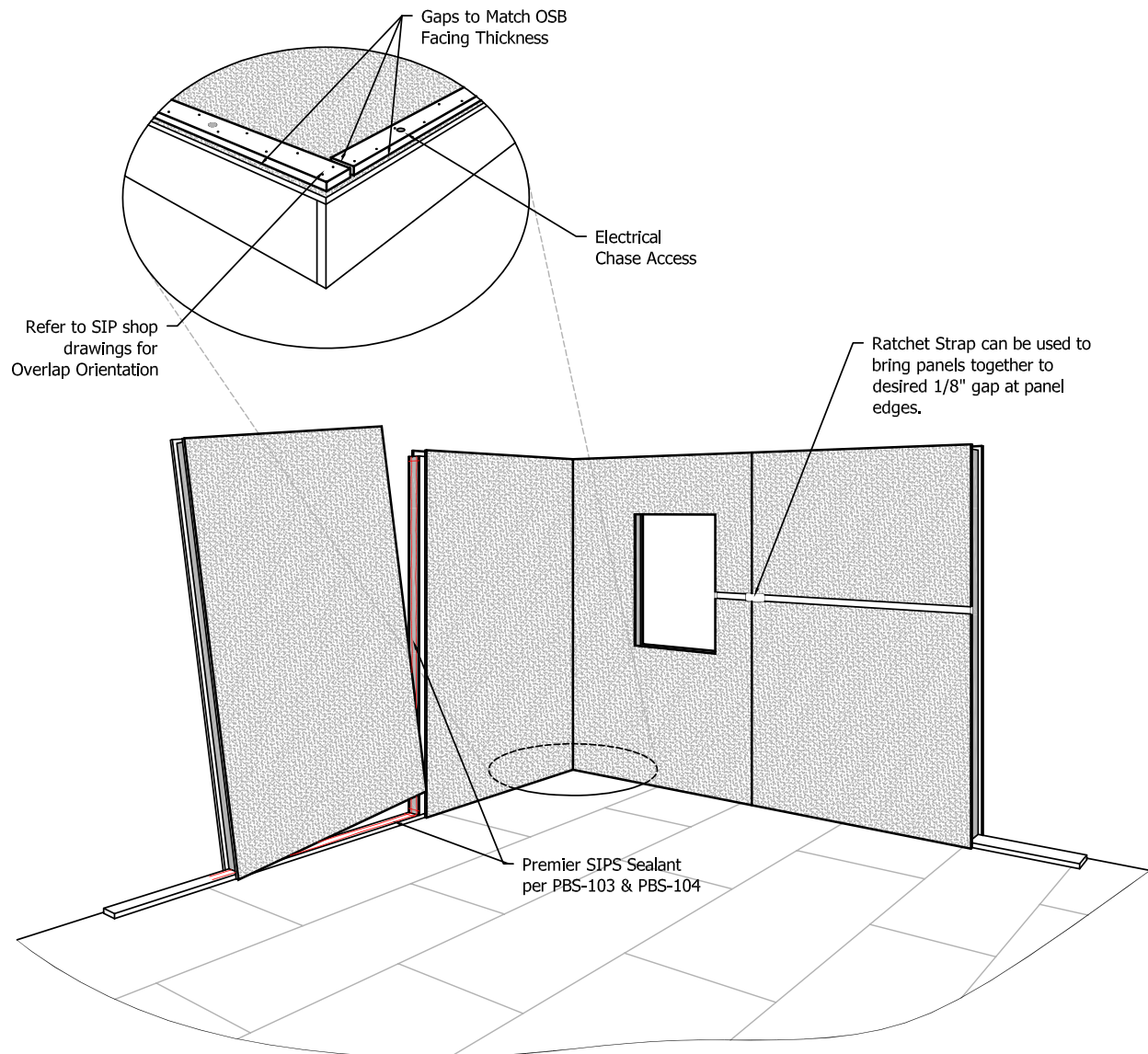

## WALL ASSEMBLY

Set out the SIPs in the order you are going to install them. Get all your tools onto the floor deck, including:

- Foam scoop
- Marker
- Flat dolly—for moving SIPs around the deck
- Come-along

### STEP 1. BOTTOM PLATE

Wall SIPs are placed over a dimensional bottom plate that fits in the recess in the wall SIP. Refer to your SIP layout drawings for the location of the bottom plate. The plate will be measured  $1/2''$  in from the outside edge of your floor. Snap a chalk line on the floor, equal to the plate width +  $1/2''$

to represent the inside edge of the bottom plate. SIP facings should run flush to the floor edge. Apply Premier SIPS Sealant per details and nail per schedule or engineering.

## **STEP 2. LAYOUT TRANSFER**

Using a black marker, transfer the SIP layouts to the bottom plate. Include all window and door openings as well as the vertical electrical chases in each wall SIP. If electrical chases are being utilized, drill the chase holes as you set each SIP using a minimum 1 1/2" bit. (Do not drill all the chase holes down the entire wall, because as SIP joints grow you will be off center as you get to the end of the wall.)

## **STEP 3. SIP TILT**

Determine the best place to start the installation and get your SIPs to that area. Most of the time it is best to start in a building corner. The corners are locked together using Premier SIPS Screws secured through the SIP spaced 2' o.c. maximum. (Normally you will use a screw two inches longer than the wall thickness.) Use a drill to finish tightening and the SIPs will cinch together. Set the underside of the screw heads flush with the OSB, do not break the OSB facing of the SIP. Always check the fastening or engineering schedule on your Layout Drawings. Check the SIP dimensions against the floor layout. Apply Premier SIPS Sealant per Premier details specific to each connection. A come-along or ratchet strap can also be used to pull the SIPs together. After the SIP is standing, check for proper placement. Next, plumb the wall section in both directions and fasten it to the plate and the adjacent SIP with the specified fasteners. If necessary, brace the wall before moving to the next SIP.

## **STEP 4. ADJACENT SIP**

Move the next SIP into position and apply Premier SIPS Sealant in the same manner as with the first SIP. Place splines on the floor and run the sealant down one side and up the other per Premier SIPS details. Set the splines into the grooves of the fixed (standing) SIP. Bring your connecting SIP into position over the bottom plate, tilted slightly away from the fixed SIP. Butt the facings together at the bottom and scissor the walls together using a sharp motion.

Reference detail PBS-103 (located in the Premier Resource Manual or at [www.premiersips.com](http://www.premiersips.com)) for additional information.

## **STEP 5. FASTENING**

Plumb the SIP in both directions. Once the SIP is plumb in both directions, nail both sides of the spline seam and the sill plate with 8d nails per plan. (You may have to brace the wall.)

## **STEP 6. TOP PLATE**

Repeat the procedures for the remaining wall SIPs. When you get to a corner or opening make sure to check the SIP dimensions before standing the SIP. (This SIP may need to be trimmed to fit the location properly.)

After all of the walls are up, prior to setting your top plate, check and plumb the alignment of each wall, getting as close to square and plumb as possible. If electrical chases are being utilized, mark the vertical chases onto your dimensional lumber top plate. Cut the top plate so that the ends of the top plate have a minimum 2' overlap with the wall SIP seams. Apply Premier SIPS Sealant per provided construction details. Set the top plate and nail it off per schedule or engineering. Finish by drilling the electrical chase access with a minimum 1 1/2" auger bit.



**VIEW VIDEO:**  
Premier  
SIPS Sealant  
Application

## SHEARWALLS

A shearwall is a vertical bracing element that transfers the in-plane forces imposed on a floor or roof diaphragm to the foundation. Wood framed buildings use shearwalls as the vertical bracing element or lateral load resisting element almost exclusively. The most common way to anchor SIPs is to measure and cut out an access plate in the SIP wall adjacent to the tension post. Allow enough room to maneuver the holdown and 2x blocking.

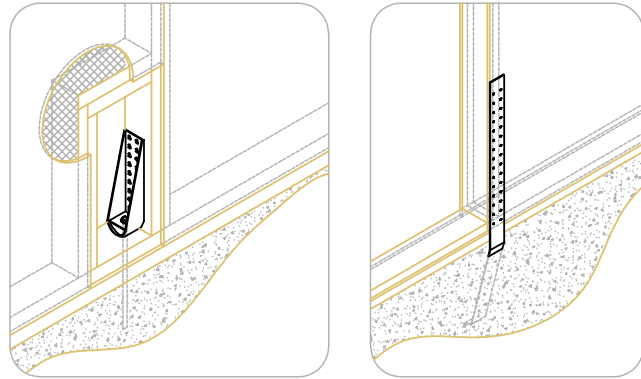

## HEADERS

LVL MEMBER INSTALLED FACING BEARING REQUIREMENT. AT SIP ROOF EAVE THIS WOULD BE BELOW BEVELED BLOCK. FOR TRUSS ROOF THIS WOULD BE FACING INTERIOR.

Reference detail PBS-411 (located in the Premier Resource Manual or at [www.premiersips.com](http://www.premiersips.com)) for additional information.

Determine trimmer height: depth of the header + the top plate + bottom plate - height of SIP = height of trimmer ( $11\frac{1}{4}'' + 1\frac{1}{2}'' + 1\frac{1}{2}'' - 96'' = 81\frac{3}{4}''$ ). Cut your trimmer and cripple, apply Premier SIPS Sealant and nail them together. Next, install the SIP that sits below the window (sill SIP) to the assembled trimmer and cripple using 8d nails per SIP Layout Drawings. Install the SIP between the top of the opening and the bottom of the IHDR (header SIP) similar to the sill SIP assembly process so that the distance between the top of the sill and bottom of the header SIP equal the window rough opening height. Measure the distance between the king studs and cut the header  $\frac{1}{8}''$  short of this. Apply Premier SIPS Sealant to the cripples and top edge of the Header SIP then install IHDR between the king studs so that the IHDR is in contact with the top of the trimmers. Nail through the kings into the IHDR. Next tilt the header/header SIP/sill SIP assembly into a vertical position and install into adjacent SIP per standard wall assembly techniques.

IHDR-2 PLY

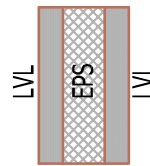

IHDR-1 PLY

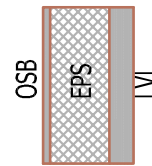

**VIEW VIDEO:**  
Premier  
SIPS Sealant  
Application

Cut your SIP top plate to be continuous over the opening and at least 2' past each end of the opening and 2' from any SIP joint. Apply Premier SIPS Sealant and install the top plate into the SIP recess and over the header. Nail the top plate to the IHDR first with (2) 16d nails 12" o.c. Nail the SIP facings on either side of the header to the top plate next, then nail down the sides of the header assembly SIPs.

Fur out both sides of the IHDR with  $\frac{7}{16}''$  sheathing to match the thickness of the SIPs, keeping the sheathing flush with the top of the top plate.

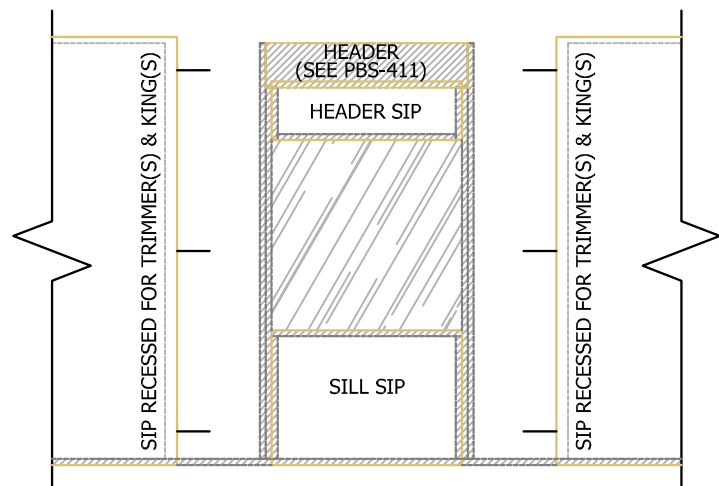

# INTERMEDIATE FLOORS

## PLATFORM FRAMING

In typical platform framing, the rim is placed on top of the SIP, flush to the exterior, and the joists are placed on top of the SIP.

(Floor joists can be either engineered wood or dimensional lumber. For more information, refer to the Premier SIPS resource manual or our website at [www.premiersips.com](http://www.premiersips.com))

## BALLOON FRAMING

Once the top plate is in, you may now also hang joists directly from the wall SIP via a ledger attached to the face of the SIP with SIP screws at a spacing specified by an engineer.

## HYBRID PLATFORM-BALLOON

The lower SIP wall can be used to insulate the floor rim when using a joist hanger with a nailable top flange. The flange should bear at least 1.5" (2" is best) on to the top plate. Nail the top flange following the fastening schedule specified by the engineer. As always, consult with your engineer of record concerning your specific design requirements.

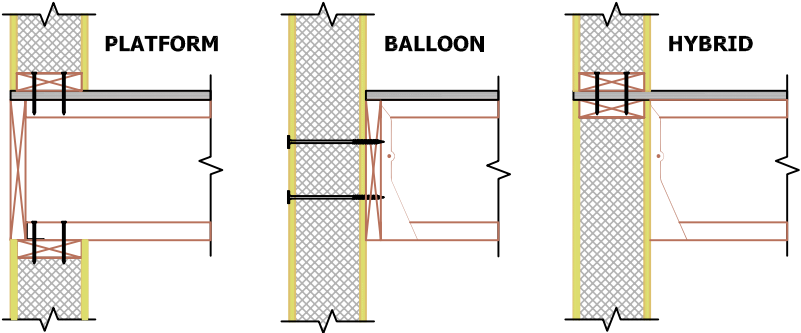

## PLUMBING

Whether you are building a standard stick frame house or a SIP home, Premier does not recommend placing plumbing chases in the exterior walls.

Situations do arise in which it becomes necessary for a builder to consider options for chases in the exterior walls such as a kitchen sink next to a window or washer and dryer unit next to an exterior wall. This situation can be answered through the use of an “island vent” through the floor to the nearest interior wall.

If plumbing in the exterior wall is unavoidable, consider furring out the wall, or you can add a stick frame void in the SIP wall and insulate conventionally.

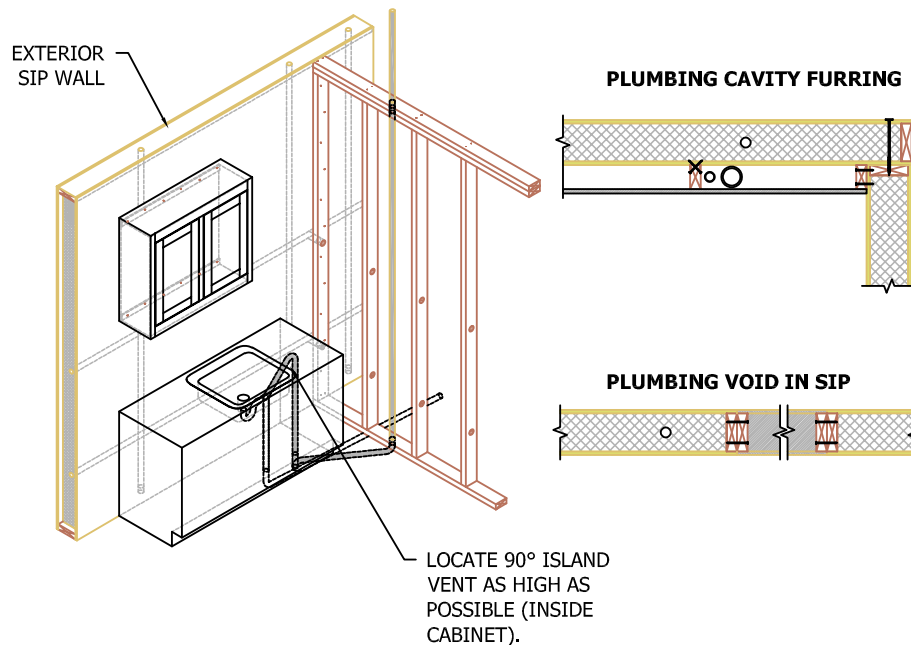

## ROOFS

If the SIPs aren't being installed immediately, cover the SIPs and lumber until ready for installation. See the “Storage of SIPs & Protection from Weather” section.

### ON THE GROUND

Prior to lifting, install as many of your dimensional lumber splines and I-joint splines as possible along the connecting sides of each roof SIP. Premier SIPs splines should be installed as SIPs are installed. The dimensional lumber at the ridge and eaves should be installed prior to SIP installation. (If SIPs are spanning perpendicular to the ridge.)

Cut a bevel block out of dimensional lumber to the same pitch as the roof and fasten the full length of the ridge. The roof SIP must bear at least 1 1/2” on the beveled block. Next, tack Premier SIP Tape that is 18” wide on top of the ridge beam per provided construction details.. (Be sure that the release paper is facing up towards the underside of the roof SIPs.)



**VIEW VIDEO:**  
Premier  
SIPs Tape  
Application

### LIFTING SIPS

Use either a lifting bracket, picking eye, or strap method to lift your roof. A 12" x 12" lifting bracket can be purchased from Premier SIPS. The plate should be secured to the SIP facings with a total of (35) #10 deck screws. Star drive screws are recommended. A 12"x12" 3/4" plywood shim can be placed between the plate and the SIP to hold screws in place between picks; just back the screws out of the SIP facings, but not all the way out of the 3/4" plywood shim, and it will speed up the process on the next roof SIP to be lifted into place.

As an alternative to lifting brackets, a picking eye can be fashioned from a 4" eye made from 3/4" steel rod. The shaft should be at least 14" long. The nut should be tack welded to a minimum 4" diameter washer made of 1/2" thick steel. Drill through the roof SIP, insert the 3/4" steel rod through the full section of the SIP, apply a 12" square 3/4" Plywood "washer", and thread on the nut welded to the 4" steel washer.

After SIPs are secured in place, remove all the lifting hardware and fill the hole in SIP with low expanding foam that is compatible with EPS. Determine the center of each SIP. Depending on the pitch of the roof, drill your hole for the picking eye, or place the center of the lifting plates, 3" from the center of the SIP toward the ridge end for every pitch change after 4:12. For example: On a 7:12 roof, the lifting hole will be 9" from the SIP center. This will allow the SIP to arrive on the ridge at almost the proper pitch, which will help the SIP installation. If you use the picking eye, be sure to fill the hole with low expanding foam prior to installing roofing felt. (If the roof SIP has installed lumber, the placement of the lifting eye or plate may need to be adjusted.) During the install care should be taken to secure the ridge beam during installation to prevent bowing.

Note: It is the sole responsibility of the contractor and lift operator to select the appropriate methods and means for placing the SIPs of the structure. Further, the contractor and lift operator are responsible for the proper installation of the SIPs following product label instructions and for using all safety precautions during installation to avoid injury to anyone on the project site. The Premier SIPS manufacturer does not accept any responsibility for improper or defective installation workmanship.

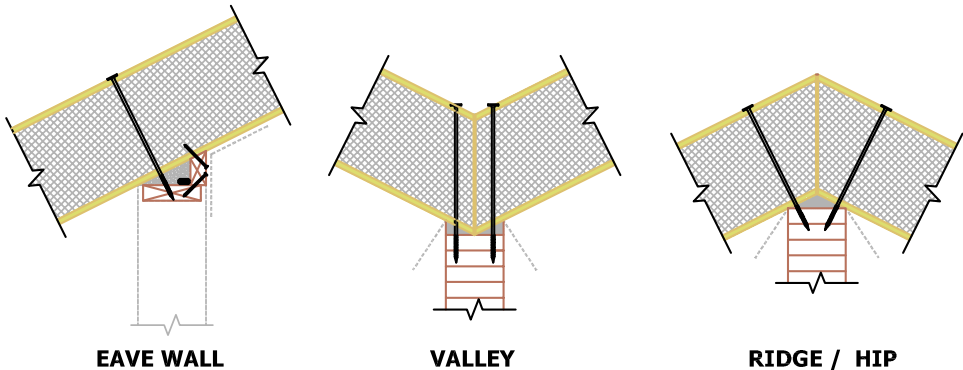

**VIEW VIDEO:**  
Premier  
SIPS Tape  
Application

In some eave wall/roof connections the electrician can run the wires in the void created by the beveled block. Once the wires are in place, install the beveled block and spray expanding foam in the void.

### VAPOR RETARDER

An appropriate vapor retarder must be installed on the interior of the roof SIPs. Premier recommends using Premier SIP Tape on the SIP joints and at the wall to roof connections. Refer to Premier SIPS Details and Technical Bulletins at [www.premiersips.com](http://www.premiersips.com) for more information on this subject.

## ELECTRICAL GENERAL GUIDELINES

1. Pre-Drill Plates and Splines at electrical chase locations within each SIP wall during SIP installation.
2. Never cut long grooves in the facing of a SIP. Long grooves in the facing can seriously compromise the structural integrity of your SIPs.
3. When necessary, you may cut 4" access holes and use a long remodelers flex bit with a catch hook to run wires where a chase may not exist.
4. Use vertical chases and interior walls whenever possible for most of your wiring needs.

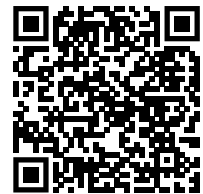
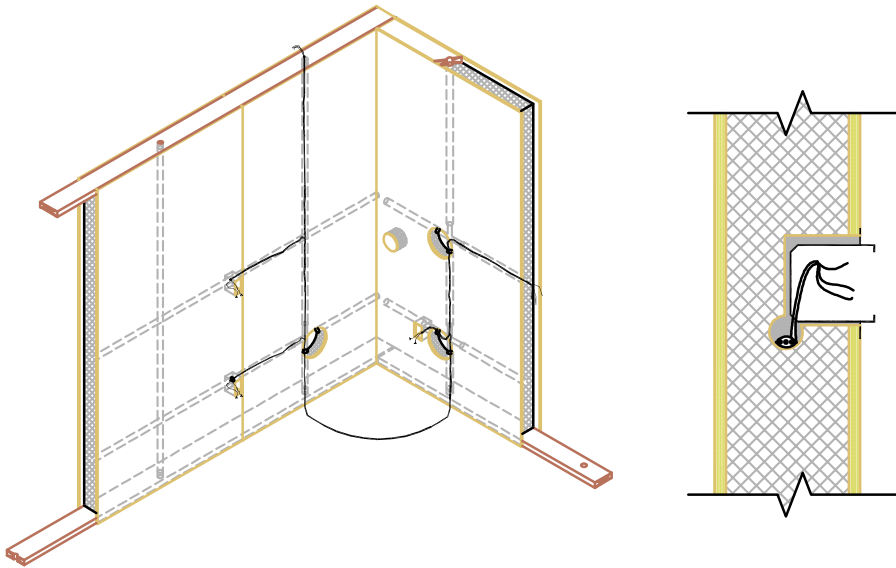

**VIEW VIDEO:**  
Running  
Electrical  
Wiring in SIPs

5. Use a remodeler's box that has flanges so the box can be fastened directly to the SIP facing.
6. Push or pull all wires through a chase simultaneously. With an electrician's pliers fold and crimp the longest wire back on itself about 1". Wrap electrical tape around that end. Stagger remaining wires flat side to flat side and tape these to the long wire below the crimp. Have 8"-10" of straight wire to slide into the electrical chase holes.
7. As a general rule, don't try to go horizontal between outlets or switches in the SIPs unless the distance is short and you have no other options. Use the vertical chases to run the wire back into the floor or attic if the roof is stick framed.
8. The triangular space on top of the wall SIP and under the roof SIP can be used as a chase if SIPs are used for the walls and roof. Refer to detail PBS-500. Run the wires horizontally in these areas to access the vertical chases in the SIPs.
9. To gain access to chase intersections, use a 4" to 4 1/8" hole saw. Use a flat blade screw driver and pry out the plug. Nail the plug to the wall for reinstallation. After pulling your wires, secure the plug with Premier SIPS Sealant or expanding foam.
10. Where walls terminate against a SIP you can drill (at the horizontal electrical chase height) a long diagonal hole through the face of the stud diagonally into the electrical chase. Electrical wires will stuff easily into this type of access.



**VIEW VIDEO:**  
Premier  
SIPS Sealant  
Application